

XY2500F-A(5.0) XY2500F-B(5.08)

Poles: Any poles (2-24P)
 Pitch: 5.0mm, 5.08mm

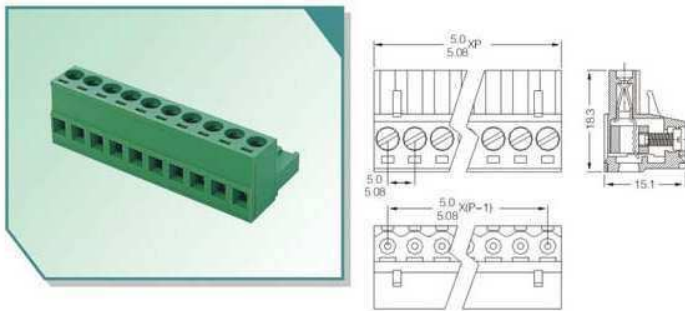

Pluggable Terminal Block Specifications:

Voltage Rating: 300V
 Current Rating: 12A
 Wire Range: 18-12AWG 2.5mm²
 Housing: PA66 (UL 94V-0)
 Wire Cage: Brass, Nickel Plated
 Clamping: Phosphor Bronze, Nickel Plated
 Screw: M2.5, steel (Q235), Zinc Plated
 Torque:0.4N.m

XY2500F-AS(5.0) XY2500F-BS(5.08)

Poles: Any poles (2-24P)
 Pitch: 5.0mm,5.08mm

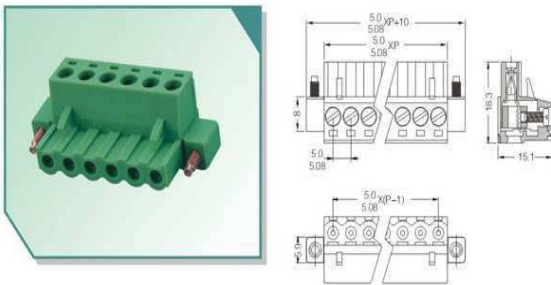

Pluggable Terminal Block Specifications:

Voltage Rating: 300V
 Current Rating: 12A
 Wire Range: 18-12AWG 2.5mm²
 Housing: PA66 (UL 94V-0)
 Wire Cage: Brass, Nickel Plated
 Clamping: Phosphor Bronze, Nickel Plated
 Screw: M2.5, steel (Q235), Zinc Plated
 Torque:0.4N.m

XY2500F-AV(5.0) XY2500F-BV(5.08)

Poles: Any poles (2-24P)
 Pitch: 5.0mm,5.08mm

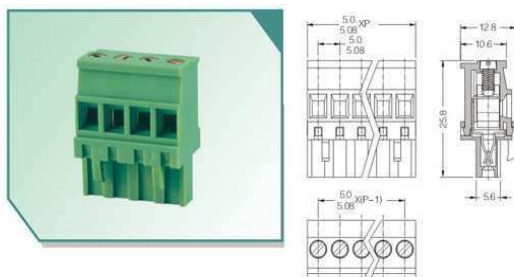

Pluggable Terminal Block Specifications:

Voltage Rating: 300V
 Current Rating: 12A
 Wire Range: 18-12AWG 2.5mm²
 Housing: PA66 (UL 94V-0)
 Wire Cage: Brass, Nickel Plated
 Clamping: Phosphor Bronze, Nickel Plated
 Screw: M3.0, steel (Q235), Zinc Plated
 Torque:0.5N.m

XY2500F-AVS(5.0)_XY2500F-BVS(5.08)

Poles: Any poles (2-24P)
 Pitch: 5.0mm, 5.08mm

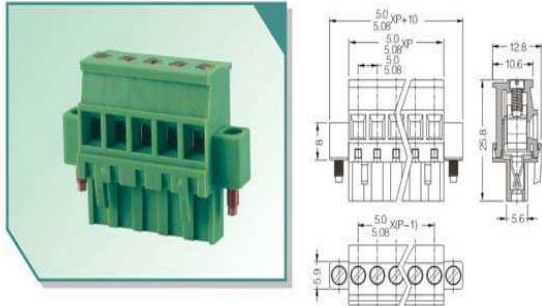

Pluggable Terminal Block Specifications:

Voltage Rating: 300V
 Current Rating: 12A
 Wire Range: 18-12AWG 2.5mm²
 Housing: PA66 (UL 94V-0)
 Wire Cage: Brass, Nickel Plated
 Clamping: Phosphor Bronze, Nickel Plated
 Screw: M3.0, steel (Q235), Zinc Plated
 Torque:0.5N.m

XY2500F-C(3.81) XY2500F-G(3.5)

Poles: Any poles (2-24P)
 Pitch: 3.5mm,3.81mm

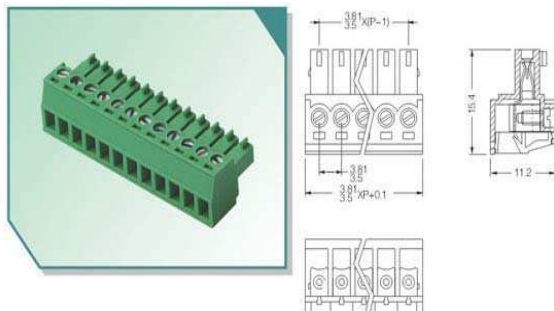

Pluggable Terminal Block Specifications:

Voltage Rating: 125V
 Current Rating: 8A
 Wire Range: 22-16AWG 1.5mm²
 Housing: PA66 (UL 94V-0)
 Wire Cage: Brass, Nickel Plated
 Clamping: Phosphor Bronze, Nickel Plated
 Screw: M2.0, steel (Q235), Zinc Plated
 Torque:0.2N.m

XY2500F-CS(3.81) XY2500F-GS(3.5)

Poles: Any poles (2-24P)
 Pitch: 3.5mm,3.81mm

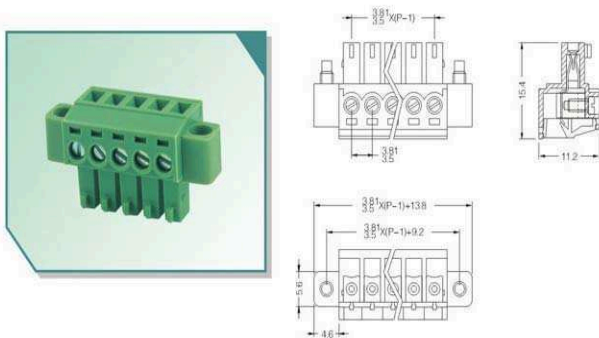

Pluggable Terminal Block Specifications:

Voltage Rating: 125V
 Current Rating: 8A
 Wire Range: 22-16AWG 1.5mm²
 Housing: PA66 (UL 94V-0)
 Wire Cage: Brass, Nickel Plated
 Clamping: Phosphor Bronze, Nickel Plated
 Screw: M2.0, steel (Q235), Zinc Plated
 Torque:0.2N.m

XY2500F-E(3.81) XY2500F-F(3.5)

Poles: Any poles (2-24P)
 Pitch: 3.5mm,3.81mm

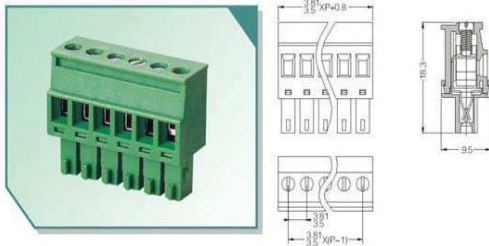

Pluggable Terminal Block Specifications:

Voltage Rating: 125V
 Current Rating: 8A
 Wire Range: 22-16AWG 1.5mm
 Housing: PA66 (UL 94V-0)
 Wire Cage: Brass, Nickel Plated
 Clamping: Phosphor Bronze, Nickel Plated
 Screw: M2.0, steel (Q235), Zinc Plated
 Torque:0.2N.m

XY2500F-ES(3.81) XY2500F-FS(3.5)

Poles: Any poles (2-24P)
 Pitch: 3.5mm,3.81mm

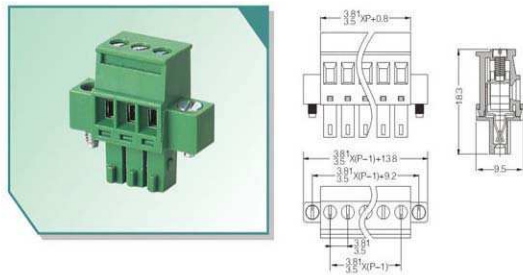

Pluggable Terminal Block Specifications:

Voltage Rating: 125V
 Current Rating: 8A
 Wire Range: 22-16AWG 1.5mm
 Housing: PA66 (UL 94V-0)
 Wire Cage: Brass, Nickel Plated
 Clamping: Phosphor Bronze, Nickel Plated
 Screw: M2.0, steel (Q235), Zinc Plated
 Torque:0.2N.m

XY2500F-M(7.5) XY2500F-N(7.62)

Poles: Any poles (2-24P)
 Pitch: 7.5mm,7.62mm

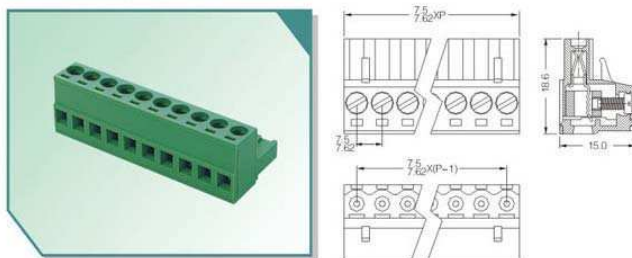

Pluggable Terminal Block Specifications:

Voltage Rating: 300V
 Current Rating: 12A
 Wire Range: 18-12AWG 2.5mm²
 Housing: PA66 (UL 94V-0)
 Wire Cage: Brass, Nickel Plated
 Clamping: Phosphor Bronze, Nickel Plated
 Screw: M2.5 steel (Q235), Zinc Plated
 Torque:0.4N.m

XY2500F-MS(7.5) XY2500F-NS(7.62)

Poles: Any poles (2-22P)
Pitch: 7.5mm,7.62mm

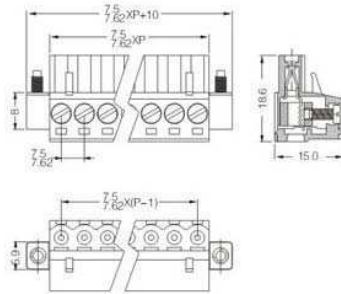

Pluggable Terminal Block Specifications:

Voltage Rating: 300V
 Current Rating: 12A
 Wire Range: 18-12AWG 2.5mm²
 Housing: PA66 (UL 94V-0)
 Wire Cage: Brass, Nickel Plated, Steel (zinc plated)
 Clamping: Phosphor Bronze, Tin plated
 Screw: M2.5 steel (Q235), Zinc Plated
 Torque:0.4N.m

XY2500F-P(7.5) XY2500F-Q(7.62)

Poles: Any poles (2-24P)
Pitch: 7.5mm,7.62mm

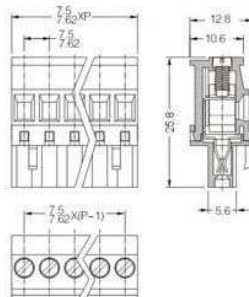

Pluggable Terminal Block Specifications:

Voltage Rating: 300V
 Current Rating: 12A
 Wire Range: 18-12AWG 2.5mm²
 Housing: PA66 (UL 94V-0)
 Wire Cage: Brass, Nickel Plated
 Clamping: Phosphor Bronze, Tin Plated
 Screw: M3.0 steel (Q235), Zinc Plated
 Torque:0.5N.m

XY2500F-PS(7.5) XY2500F-QS(7.62)

Poles: Any poles (2-22P)
Pitch: 7.5mm,7.62mm

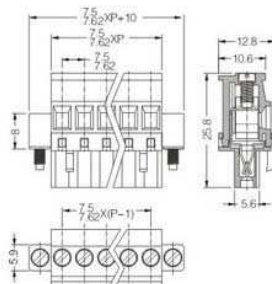

Pluggable Terminal Block Specifications:

Voltage Rating: 300V
 Current Rating: 12A
 Wire Range: 18-12AWG 2.5mm²
 Housing: PA66 (UL 94V-0)
 Wire Cage: Brass, Nickel Plated
 Clamping: Phosphor Bronze, Tin Plated
 Screw: M3.0 steel (Q235), Zinc Plated
 Torque:0.5N.m

XY2500R-A(5.0) XY2500R-C(5.08)

Poles: Any poles (4-48P)
 Pitch: 5.0mm,5.08mm

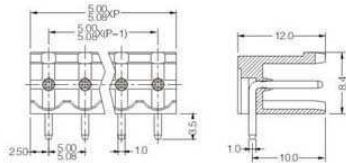
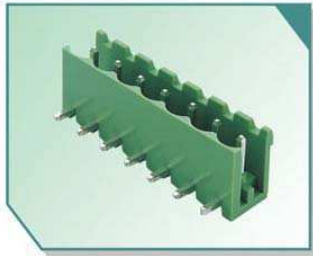

Pluggable Terminal Block Specifications:

Voltage Rating: 300V
 Current Rating: 12A
 Housing: PA66 (UL 94V-0)
 Solder Pin: Brass, Tin Plated

XY2500R-B(5.0) XY2500R-D(5.08)

Poles: Any poles (4-48P)
 Pitch: 5.0mm,5.08mm

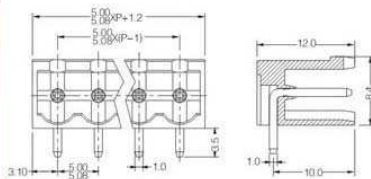
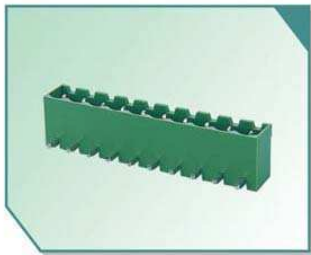

Pluggable Terminal Block Specifications:

Voltage Rating: 300V
 Current Rating: 12A
 Housing: PA66 (UL 94V-0)
 Solder Pin: Brass, Tin Plated

XY2500R-BS(5.0) XY2500R-DS(5.08)

Poles: Any poles (4-44P)
 Pitch: 5.0mm,5.08mm

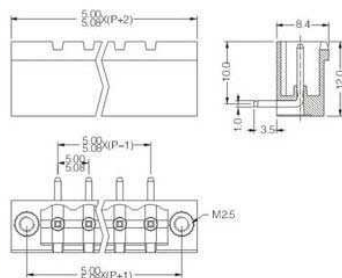
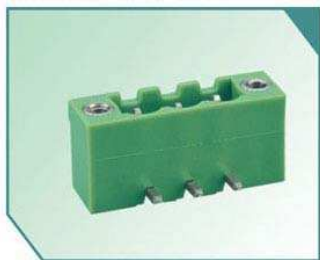

Pluggable Terminal Block Specifications:

Voltage Rating: 300V
 Current Rating: 12A
 Housing: PA66 (UL 94V-0)
 Solder Pin: Brass, Tin Plated

XY2500R-F(3.81) XY2500R-G(3.5)

Poles: Any poles (2-16P)
Pitch: 3.5mm,3.81mm

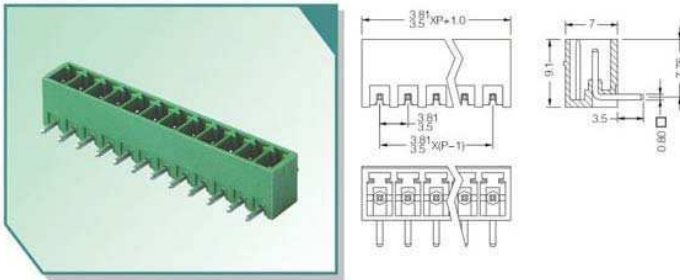

Pluggable Terminal Block Specifications:

Voltage Rating: 125V
 Current Rating: 8A
 Housing: PA66 (UL 94V-0)
 Solder Pin: Brass, Tin Plated

XY2500R-FS(3.81) XY2500R-GS(3.5)

Poles: Any poles (2-14P)
Pitch: 3.5mm,3.81mm

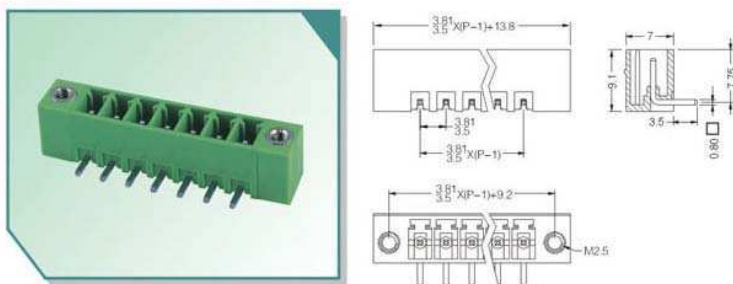

Pluggable Terminal Block Specifications:

Voltage Rating: 125V
 Current Rating: 8A
 Housing: PA66 (UL 94V-0)
 Solder Pin: Brass, Tin Plated

XY2500R-M(7.5) XY2500R-N(7.62)

Poles: Any poles (2-24P)
Pitch: 7.5mm,7.62mm

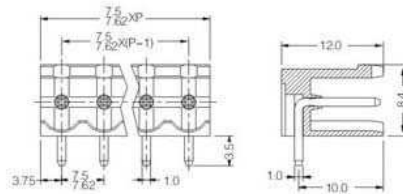
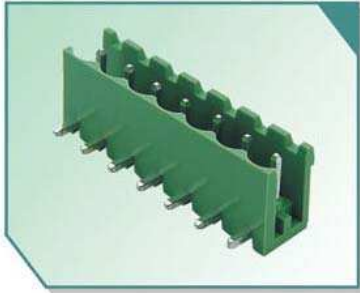

Pluggable Terminal Block Specifications:

Voltage Rating: 300V
 Current Rating: 12A
 Housing: PA66 (UL 94V-0)
 Solder Pin: Brass, Tin Plated

XY2500R-P(7.5) XY2500R-Q(7.62)

Poles: Any poles (2-24P)
Pitch: 7.5mm,7.62mm

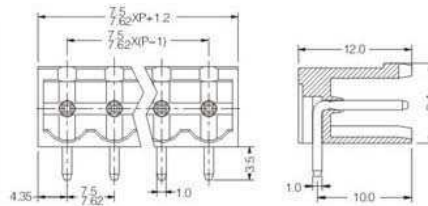
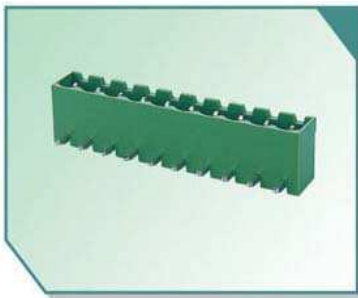

Pluggable Terminal Block Specifications:

Voltage Rating: 300V
 Current Rating: 12A
 Housing: PA66 (UL 94V-0)
 Solder Pin: Brass, Tin Plated

XY2500R-PS(7.5) XY2500R-QS(7.62)

Poles: Any poles (2-22P)
Pitch: 7.5mm,7.62mm

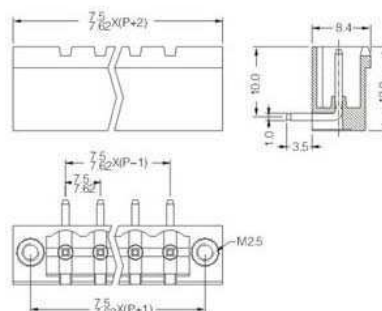

Pluggable Terminal Block Specifications:

Voltage Rating: 300V
 Current Rating: 12A
 Housing: PA66 (UL 94V-0)
 Solder Pin: Brass, Tin Plated

XY2500V-A(5.0) XY2500V-C(5.08)

Poles: Any poles (2-24P)

Pitch: 5.0mm,5.08mm

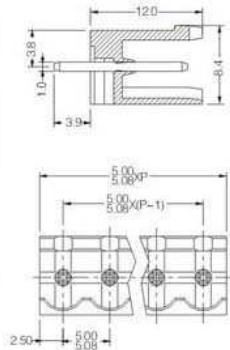
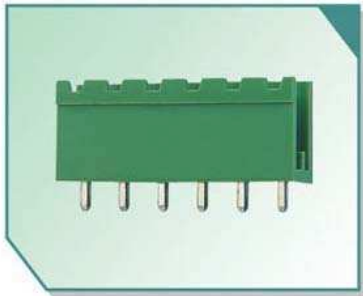

Pluggable Terminal Block Specifications:

Voltage Rating: 300V

Current Rating: 12A

Housing: PA66 (UL 94V-0)

Solder Pin: Brass, Tin Plated

XY2500V-B(5.0) XY2500V-D(5.08)

Poles: Any poles (2-24P)

Pitch: 5.0mm,5.08mm

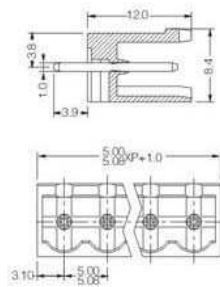
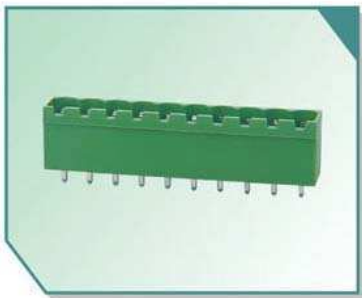

Pluggable Terminal Block Specifications:

Voltage Rating: 300V

Current Rating: 12A

Housing: PA66 (UL 94V-0)

Solder Pin: Brass, Tin Plated

XY2500V-E(3.81) XY2500V-F(3.5)

Poles: Any poles (2-16P)

Pitch: 3.5mm,3.81mm

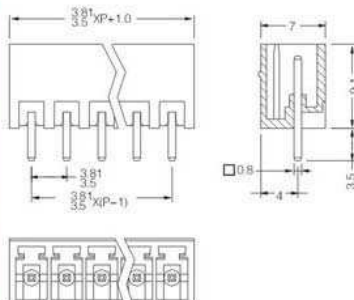
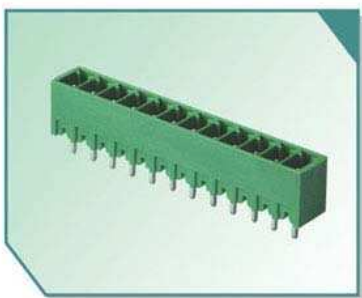

Pluggable Terminal Block Specifications:

Voltage Rating: 125V

Current Rating: 8A

Housing: PA66 (UL 94V-0)

Solder Pin: Brass, Tin Plated

XY2500V-ES(3.81) XY2500V-FS(3.5)

Poles: Any poles (2-14P)
Pitch: 3.5mm,3.81mm

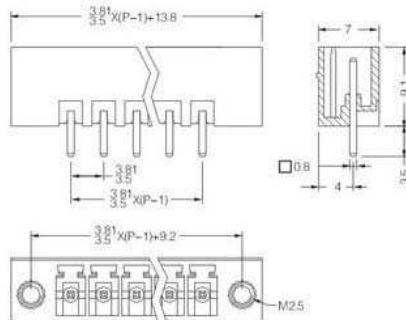

Pluggable Terminal Block Specifications:

Voltage Rating: 125V
 Current Rating: 8A
 Housing: PA66 (UL 94V-0)
 Solder Pin: Brass, Tin Plated

XY2500V-M(7.5) XY2500V-N(7.62)

Poles: Any poles (2-24P)
Pitch: 7.5mm,7.62mm

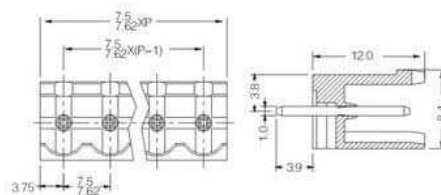
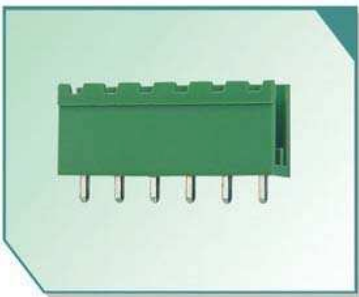

Pluggable Terminal Block Specifications:

Voltage Rating: 300V
 Current Rating: 12A
 Housing: PA66 (UL 94V-0)
 Solder Pin: Brass, Tin Plated

XY2500V-P(7.5) XY2500V-Q(7.62)

Poles: Any poles (2-24P)
Pitch: 7.5mm,7.62mm

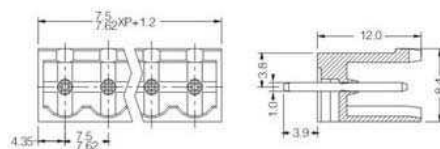

Pluggable Terminal Block Specifications:

Voltage Rating: 300V
 Current Rating: 12A
 Housing: PA66 (UL 94V-0)
 Solder Pin: Brass, Tin Plated

XY2500F-K(5.0)_XY2500F-L(5.08)

Poles: Any poles (2-24P)
 Pitch: 5.0mm, 5.08mm

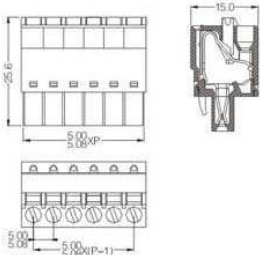

Pluggable Terminal Block Specifications:

- Voltage Rating: 300V
- Current Rating: 12A
- Wire Range: 18-12AWG 2.5mm²
- Housing: PA66 (UL 94V-0)
- Clamp: Phosphor Bronze, Nickel Plated
- Clamping: SUS301

XY2500F-KS(5.0) XY2500F-LS(5.08)

Poles: Any poles (2-22P)
 Pitch: 5.0mm,5.08mm

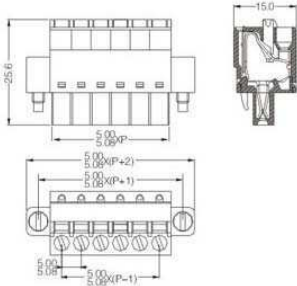

Pluggable Terminal Block Specifications:

- Voltage Rating: 300V
- Current Rating: 12A
- Wire Range: 18-12AWG 2.5mm²
- Housing: PA66 (UL 94V-0)
- Clamp: Phosphor Bronze, Nickel Plated
- Clamping: SUS301

XY2500F-H(5.0) XY2500F-I(5.08)

Poles: Any poles (2-24P)
 Pitch: 5.0mm,5.08mm

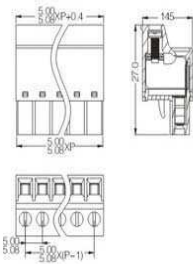

Pluggable Terminal Block Specifications:

- Voltage Rating: 300V
- Current Rating: 12A
- Wire Range: 18-12AWG 2.5mm²
- Housing: PA66 (UL 94V-0)
- Wire Cage: Brass, Nickel Plated
- Clamping: Phosphor Bronze, Nickel Plated
- Screw: M3.0, steel (Q235), Zinc Plated
- Torque: 0.5N.m

XY2500HR-AS(5.0)_XY2500HR-BS(5.08)

Poles: Any poles (4-44P)
Pitch: 5.0mm,5.08mm

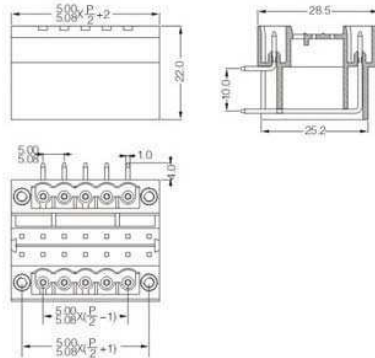
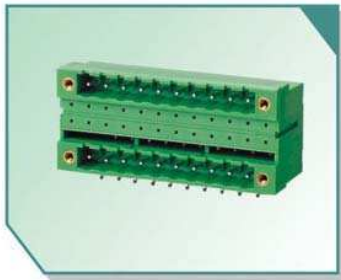

Pluggable Terminal Block Specifications:

Voltage Rating: 300V
 Current Rating: 12A
 Housing: PA66 (UL 94V-0)
 Solder Pin: Brass, Tin Plated

XY2500HR-E(3.81)_XY2500HR-F(3.5)

Poles: Any poles (4-32P)
Pitch: 3.81mm,3.5mm

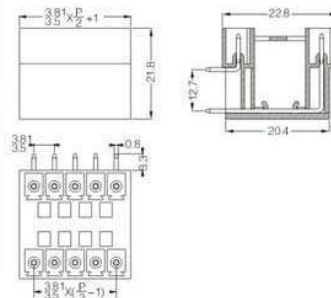
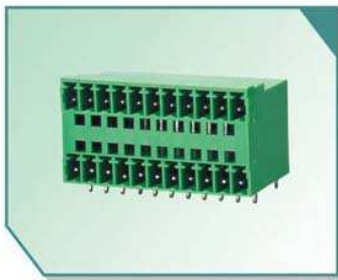

Pluggable Terminal Block Specifications:

Voltage Rating: 125V
 Current Rating: 8A
 Housing: PA66 (UL 94V-0)
 Solder Pin: Brass, Tin Plated

XY2500HR-ES(3.81)_XY2500HR-FS(3.5)

Poles: Any poles (4-28P)
Pitch: 3.5mm,3.81mm

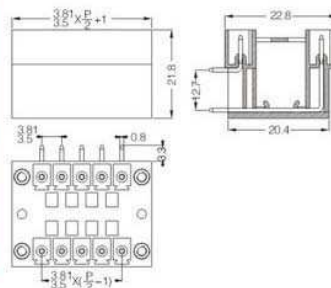

Pluggable Terminal Block Specifications:

Voltage Rating: 125V
 Current Rating: 8A
 Housing: PA66 (UL 94V-0)
 Solder Pin: Brass, Tin Plated

XY2500HV-A(5.0) XY2500HV-B(5.08)

Poles: Any poles (4-48P)
Pitch: 5.0mm,5.08mm

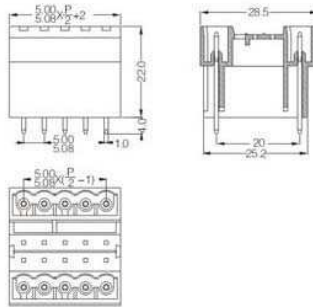

Pluggable Terminal Block Specifications:

Voltage Rating: 300V
 Current Rating: 12A
 Housing: PA66 (UL 94V-0)
 Solder Pin: Brass, Tin Plated

XY2500HV-AS(5.0) XY2500HV-BS(5.08)

Poles: Any poles (4-44P)
Pitch: 5.0mm,5.08mm

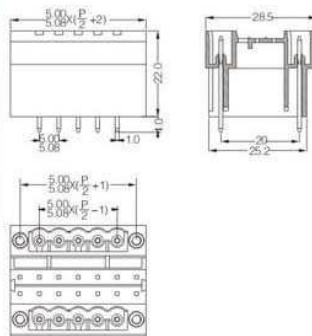
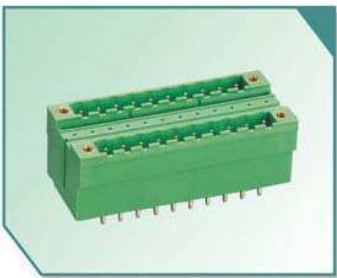

Pluggable Terminal Block Specifications:

Voltage Rating: 300V
 Current Rating: 12A
 Housing: PA66 (UL 94V-0)
 Solder Pin: Brass, Tin Plated

XY2500HV-E(3.81) XY2500HV-F(3.5)

Poles: Any poles (4-32P)
Pitch: 3.5mm,3.81mm

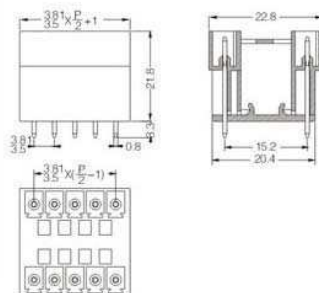
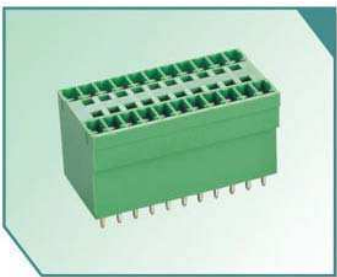

Pluggable Terminal Block Specifications:

Voltage Rating: 125V
 Current Rating: 8A
 Housing: PA66 (UL 94V-0)
 Solder Pin: Brass, Tin Plated

XY2500HV-ES(3.81) XY2500HV-FS(3.5)

Poles: Any poles (4-28P)
 Pitch: 3.5mm,3.81mm

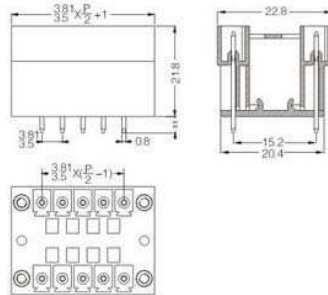

Pluggable Terminal Block Specifications:

Voltage Rating: 125V
 Current Rating: 8A
 Housing: PA66 (UL 94V-0)
 Solder Pin: Brass, Tin Plated

XY2500L-B(5.0) XY2500L-D(5.08)

Poles: Any poles (2-24P)
 Pitch: 5.0mm,5.08mm

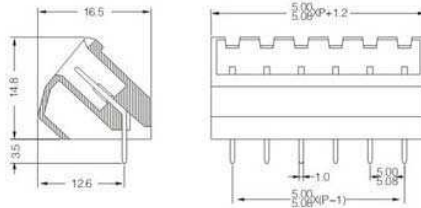

Pluggable Terminal Block Specifications:

Voltage Rating: 300V
 Current Rating: 12A
 Housing: PA66 (UL 94V-0)
 Solder Pin: Brass, Tin Plated

XY2500L-E(3.81) XY2500L-F(3.5)

Poles: Any poles (2-16P)
 Pitch: 3.5mm,3.81mm

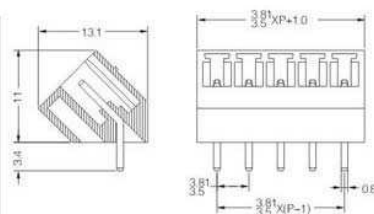
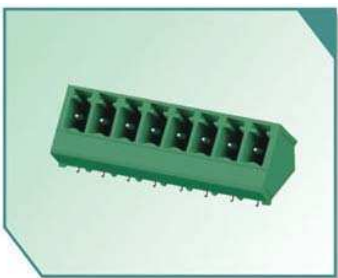

Pluggable Terminal Block Specifications:

Voltage Rating: 125V
 Current Rating: 8A
 Housing: PA66 (UL 94V-0)
 Solder Pin: Brass, Tin Plated

XY2500TR-A(5.0) XY2500TR-C(5.08)

Poles: Any poles (4-48P)
Pitch: 5.0mm,5.08mm

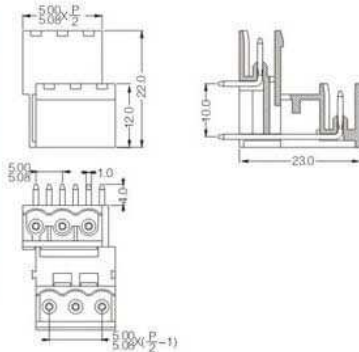

Pluggable Terminal Block Specifications:

Voltage Rating: 300V
 Current Rating: 12A
 Housing: PA66 (UL 94V-0)
 Solder Pin: Brass, Tin Plated

XY2500TR-BS(5.0) XY2500TR-DS(5.08)

Poles: Any poles (4-44P)
Pitch: 5.0mm,5.08mm

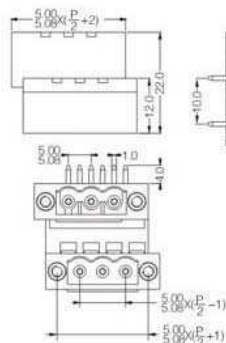
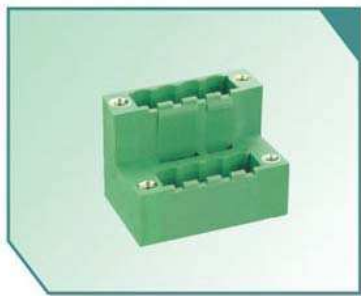

Pluggable Terminal Block Specifications:

Voltage Rating: 300V
 Current Rating: 12A
 Housing: PA66 (UL 94V-0)
 Solder Pin: Brass, Tin Plated

XY2500TR-ES(3.81) XY2500TR-FS(3.5)

Poles: Any poles (4-32P)
Pitch: 3.5mm,3.81mm

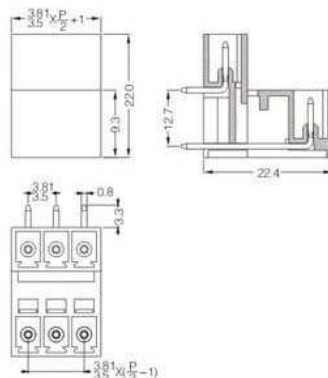

Pluggable Terminal Block Specifications:

Voltage Rating: 125V
 Current Rating: 8A
 Housing: PA66 (UL 94V-0)
 Solder Pin: Brass, Tin Plated

XY2500TR-ES(3.81) XY2500TR-FS(3.5)

Poles: Any poles (4-28P)

Pitch: 3.5mm,3.81mm

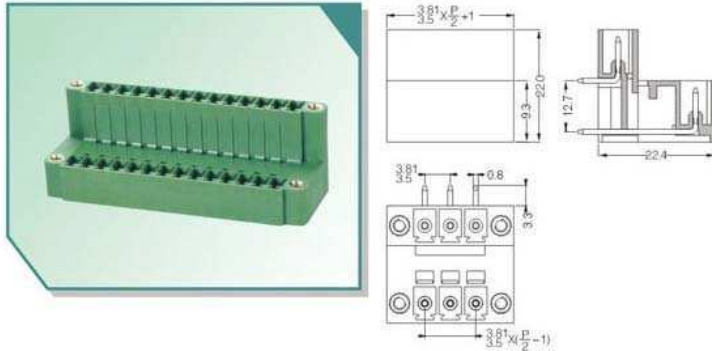

Pluggable Terminal Block Specifications:

Voltage Rating: 125V
 Current Rating: 8A
 Housing: PA66 (UL 94V-0)
 Solder Pin: Brass, Tin Plated

XY2500TV-A(5.0) XY2500TV-C(5.08)

Poles: Any poles (4-48P)

Pitch: 5.0mm,5.08mm

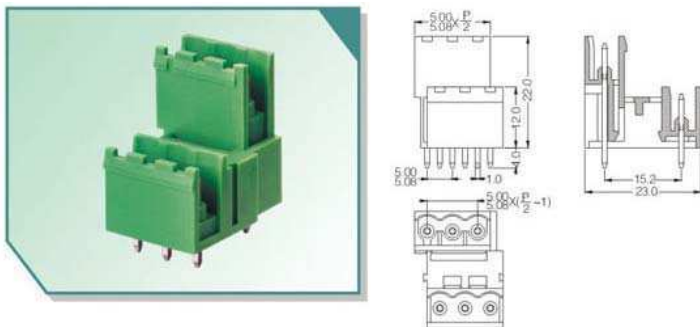

Pluggable Terminal Block Specifications:

Voltage Rating: 300V
 Current Rating: 12A
 Housing: PA66 (UL 94V-0)
 Solder Pin: Brass, Tin Plated

XY2500TV-B(5.0) XY2500TV-D(5.08)

Poles: Any poles (4-44P)

Pitch: 5.0mm,5.08mm

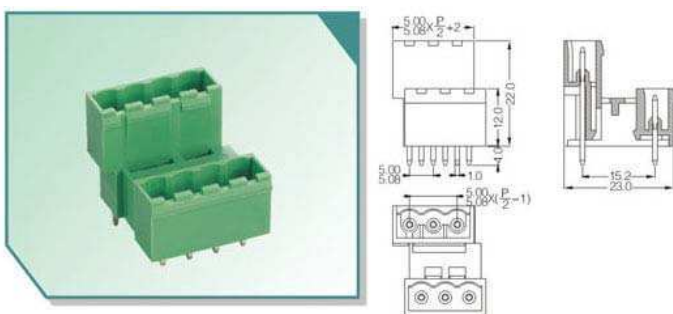

Pluggable Terminal Block Specifications:

Voltage Rating: 300V
 Current Rating: 12A
 Housing: PA66 (UL 94V-0)
 Solder Pin: Brass, Tin Plated

XY2500TV-BS(5.0) XY2500TV-DS(5.08)

Poles: Any poles (4-44P)

Pitch: 5.0mm,5.08mm

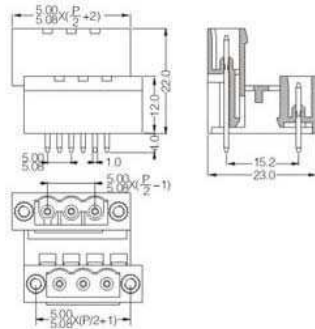
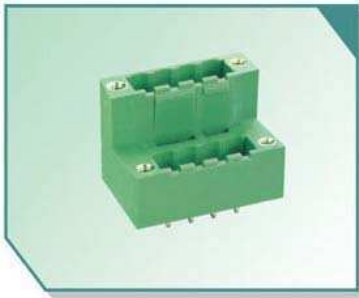

Pluggable Terminal Block Specifications:

Voltage Rating: 300V

Current Rating: 12A

Housing: PA66 (UL 94V-0)

Solder Pin: Brass, Tin Plated

XY2500TV-E(3.81) XY2500TV-F(3.5)

Poles: Any poles (4-32P)

Pitch: 3.5mm,3.81mm

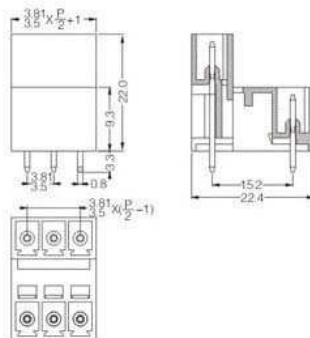

Pluggable Terminal Block Specifications:

Voltage Rating: 125V

Current Rating: 8A

Housing: PA66 (UL 94V-0)

Solder Pin: Brass, Tin Plated

XY2500TV-ES(3.81) XY2500TV-FS(3.5)

Poles: Any poles (4-28P)

Pitch: 3.5mm,3.81mm

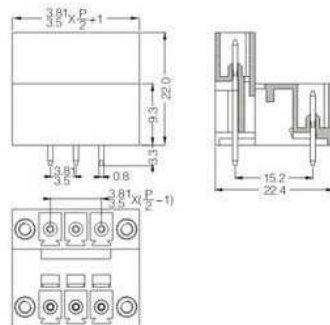

Pluggable Terminal Block Specifications:

Voltage Rating: 125V

Current Rating: 8A

Housing: PA66 (UL 94V-0)

Solder Pin: Brass, Tin Plated